

Loria 6000

Air/water heat pump single service split system

Loria 6010

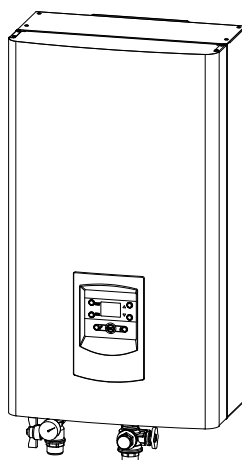
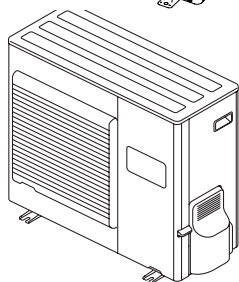
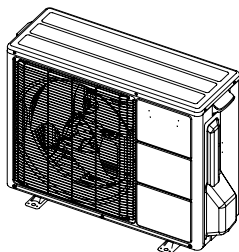

Loria 6004
Loria 6006
Loria 6008



Document No. 1634-4 ~ 26/04/2016

FR

NL

DE

EN

PL

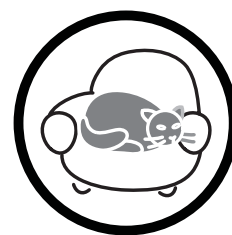

User manual

for professionals
and users

to be kept by the user
for future reference

atlantic-comfort.com

Subject to modifications without notice.
Document not binding.

Contents

Safety instructions	3
Overall view of the installation	4
Precautions and warnings regarding your installation . 4	
The outdoor unit	4
The hydraulic unit	4
The controller	4
The radiators	4
Floor heating systems	4
Fan-coil heaters with integrated control system . 4	
Domestic hot water (DHW)	4
End of life of the device	5
Overall view of the installation	5
Operation of the installation	6
User interface and description of the display	6
Commissioning the appliance	8
Commissioning	
WITHOUT room thermostat	8
Basic display	8
Time setting	9
Selecting the MODE and setting the TIME PROGRAMME depending on the USE	10
Setting the temperature setpoints	12
Selecting the DHW* MODE and setting the DHW TIME PROGRAMME	14
Regulation parameters	16
Overview	16
Setting parameters on the user interface	16
List of "End User" parameters	16
Information and troubleshooting	18
Displaying information	18
Hydraulic unit errors	18
Outdoor unit errors	20
Maintenance	20
Regular checks	20
Outdoor unit check	20
Room thermostat UA55 (optional)	21
Room thermostat* and description of the display . . 22	
Commissioning WITH room thermostat	22
Setting the time and day	23
Mode selection	23
Automatic mode: setting the TIME PROGRAMME and the temperature setpoint	24
Constant mode: setting the temperature setpoint . 25	
Holiday mode	25
Standby mode	26
Exemption function – "Boost" button	26
Information screen – Knob button	26
Stopping heating	26
Stopping the DHW*	27
ERP performance values	28
ERP definition	28
ERP Specifications	28
Package sheet	30

* Optional

1 Safety instructions

☞ Please comply with the following instructions in order to avoid any risk of injury or inappropriate use of the appliance.

• Commissioning

- ☞ Do not switch the appliance on until all filling operations are complete.
- ☞ Do not try to install this appliance yourself. This heat pump must be installed by qualified personnel with a certificate of capacity.
- ☞ The installation must always be connected to the Earth and fitted with a protective circuit breaker.
- ☞ Do not modify the electricity supply.
- ☞ The appliances are not fireproof and should therefore not be installed in a potentially explosive atmosphere.

• Use

- ☞ This appliance may be used by children aged 8 years or more and by people with physical, sensual or metal deficits and lacking experience or knowledge of the device provided that they are correctly supervised or have been provided with instructions regarding the safe use of the appliance and provided that the risks present have been fully understood. Children are not permitted to play with the appliance. This appliance must not be cleaned or maintained by children without supervision.
- ☞ Do not let children insert foreign bodies into the fan protection grill or climb on top of the outdoor unit. The blades in the air exchanger are extremely thin and may cause cutting injuries.
- ☞ Nothing should obstruct the air from circulating through the evaporator and out of the fan.
- ☞ The outdoor unit must only be installed outdoors. If a shelter is required, it must have broad openings on all 4 walls and comply with the installation clearances (check with your installer).
- ☞ Do not climb on the top of the outdoor unit.
- ☞ The room in which the appliance is operating must be correctly ventilated in order to prevent any loss of oxygen in the event of a refrigerant gas leak.
- ☞ For safety reasons, consult your installer before making any changes or modifications to the premises where the appliance is installed.
- ☞ Do not place a heat source under the room thermostat.

• Maintenance

- ☞ Do not try to repair this appliance yourself.
- ☞ This appliance does not contain any components capable of being repaired by the user. Removing either of the covers can expose you to dangerous electrical voltages.
- ☞ In any case, switching off the current is not sufficient to protect you from any external electrical shocks (capacitors)
- ☞ Do not open the heat pump while it is in operation.
- ☞ Switch off the power supply if there are any abnormal noises, smells or smoke coming from the appliance and contact your installer.
- ☞ Switch off the power to the appliance before cleaning.
- ☞ Do not use aggressive cleaning liquids or solvents to clean the body work.
- ☞ Do not use a pressure washer to clean the heat pump. This may damage the air exchanger and cause water to penetrate the electrical circuits.

2 Overall view of the installation

2.1 Precautions and warnings regarding your installation

2.1.1 The outdoor unit

The outdoor unit contains the equipment for capturing energy from the ambient air.

Your installer has placed this unit in a location that enables it to operate in an optimum manner.

Nothing should obstruct the air from circulating through the evaporator and out of the fan.

The water contained in the ambient air may condense and drain from the outdoor unit.

In cold periods, this water freezes in contact with the exchanger and must be removed by regular defrosting cycles. The control system automatically controls the defrosting cycle, whose operation can lead to the emission of steam, which is perfectly normal.

2.1.2 The hydraulic unit

The hydraulic unit contains the entire heat pump control system, in charge of controlling the heating comfort level and the production of domestic hot water (if the installation is equipped with a DHW tank and electrical back-up).

The hydraulic unit is equipped with an electrical back-up system, which is designed to provide additional heat during the coldest periods.

2.1.3 The controller

Your installer has carefully adjusted your installation. Do not modify setting parameters without their agreement. If in doubt, do not hesitate to contact them.

Your heating system is controlled according to the outdoor temperature (weather-dependent system).

A room thermostat (optional) can be installed for improved control (the influence of the room temperature is taken into account).

2.1.4 The radiators

To guarantee control, the room in which the room thermostat is installed must not have a thermostatic valve. If this is the case, the valves must be open fully.

2.1.5 Floor heating systems

New floor heating systems must be initially heated slowly to avoid cracking. Check with your installer that this initial heating procedure has been performed before using your heating system as you see fit.

The high inertia of floor heating systems prevent sudden differences in room temperature. However, this stability involves a reaction time of about several hours, (approximately 6 hours).

Any changes to the settings must be made slowly, allowing the installation time to react. Adjusting the system to exaggerated settings or in an untimely manner always results in significant temperature fluctuations during the course of the day.

Similarly if your residence has a floor heating system, do not reduce the heating or switch it off if you will be absent for a short period. The reheating period is always quite long (approx 6 hours).

2.1.6 Fan-coil heaters with integrated control system

Do not use a room thermostat in the zone concerned.

2.1.7 Domestic hot water (DHW)

This function is designed as an optional extra with the use of a DHW tank (with an electrical back-up heater).

When DHW is in demand, the heat pump prioritises this demand.

No space heating takes place while domestic hot water is being produced.

Domestic hot water (DHW) is produced by the heat pump and then topped up, if necessary, by the electrical back-up system.

In the event of extreme outdoor temperatures, the electrical back-up system of the DHW tank must be left in operation to guarantee a DHW setpoint greater than 45°C.

The electrical back-up heating enables Legionella cycles to be conducted efficiently.

2.2 End of life of the device

The apparatus must be dismantled and recycled by a specialised service provider.

The apparatus must never be disposed of with household waste, large objects or in a landfill.

When the apparatus reaches its end of life, please contact you installer or the local representative in order to proceed with the dismantling and recycling of this apparatus.

2.3 Overall view of the installation

Your heat pump has been configured by your installer. It is composed of the following main elements:

- The outdoor unit is positioned, as its name indicates, outside of your residence and extracts energy from the outdoor air.
- The hydraulic unit positioned in your boiler room, cellar, garage or even in your kitchen, transfers the energy to the heating circuit.
- The outdoor sensor detects the outdoor temperature.
- The room thermostat(s).

The heat pumps are systems that can be connected to any form of **low-temperature distribution**: the heat captured by the heat pump can therefore be used in different ways:

- Radiators.
- Heating (or cooling) floor systems.
- Dynamic radiators or fan-coil heaters.
- Domestic hot water (DHW).

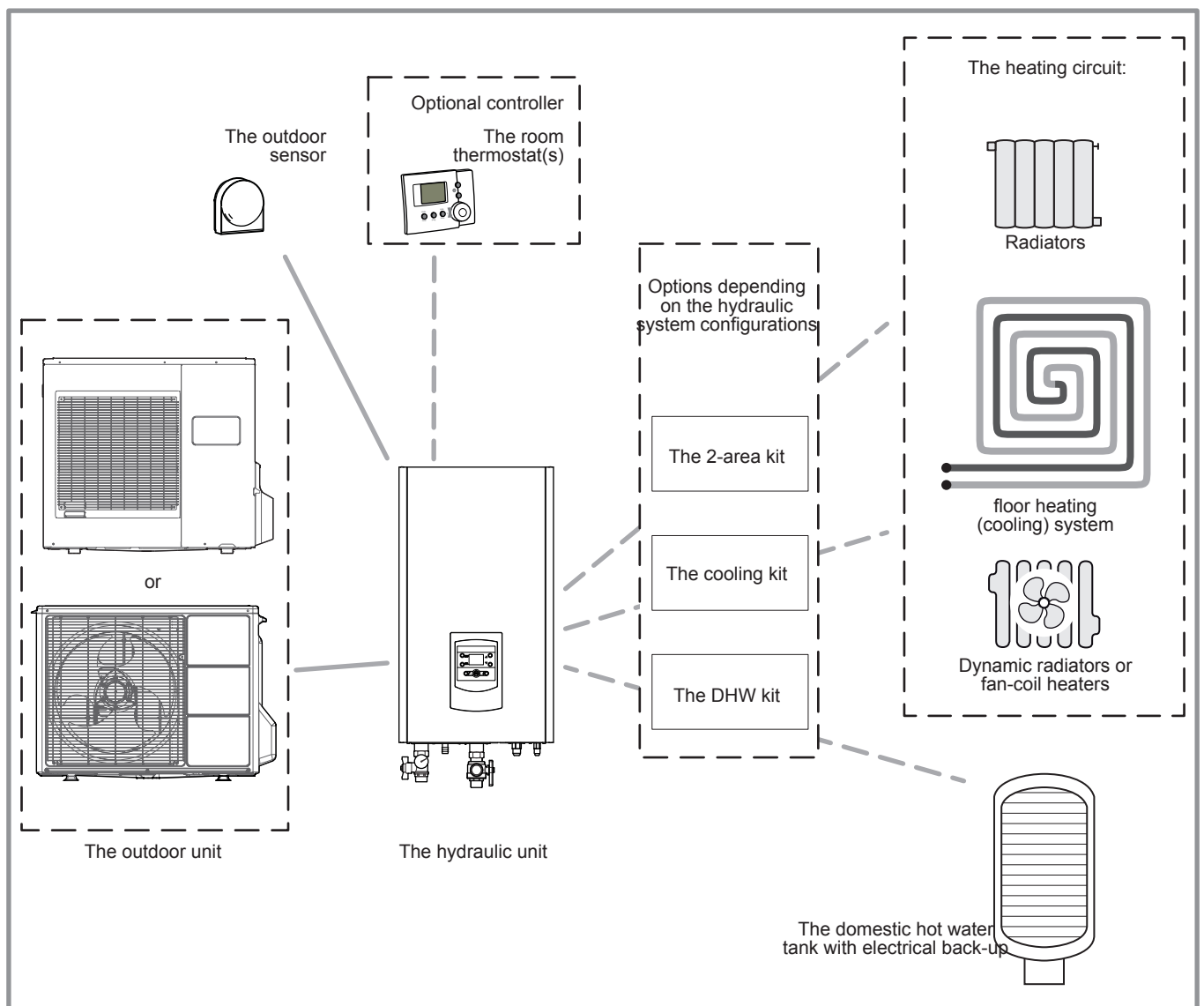

figure 1 - Overall view of the configuration of a complete installation

3 Operation of the installation

3.1 User interface and description of the display

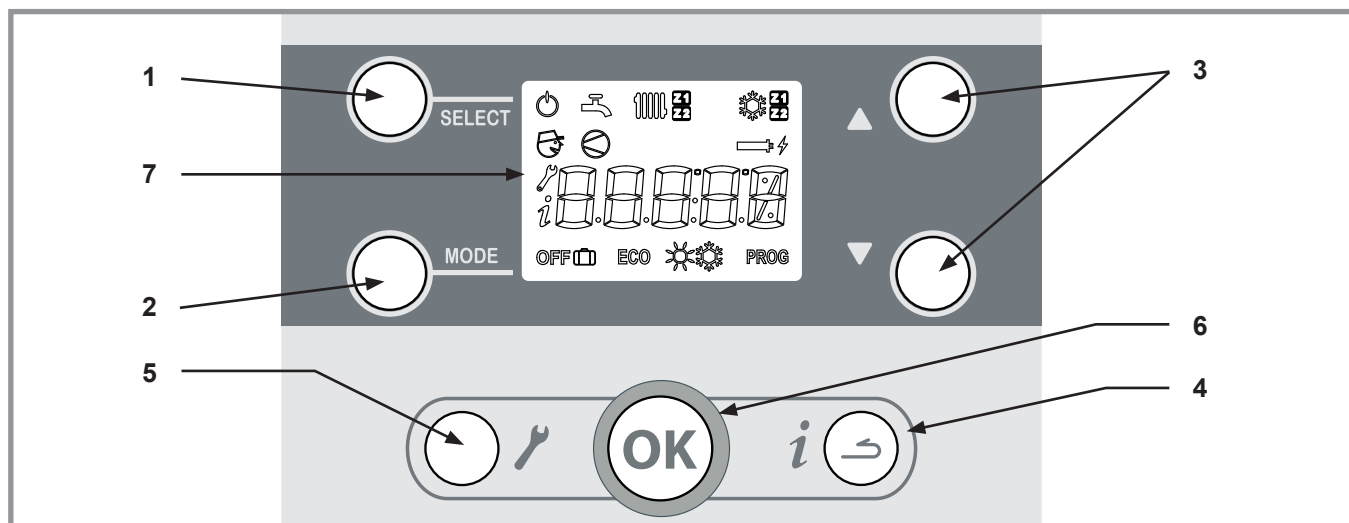



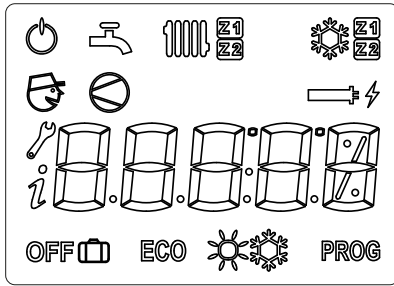

figure 2 - User interface

Ref.	Functions	- Definition of the functions
1	• SELECT	- Browse and select the available uses .
2	• MODE	- Browse and select the mode for the pre-selected use.
3	• Settings • Scrolling	- Configure the setpoints of the selected function using the ▲ and ▼ keys . - Scroll through the information and parameter lines. - Configure the modifiable values (after pressing OK to confirm).
4	• Information • "ESC" output	- Access the " information " menu (the <i>i</i> icon appears). - Exit the menu currently displayed - Cancel a modification being made
5	• Configuration	- Access the user level (press and release: the  icon appears). List of parameters  : see 4.3, page 16. - Access the installer level (press and hold (for more than 5s): the  icon appears).
6	• OK	- Confirm (Configuration, Setpoint for the pre-selected mode)
7	• Digital display	- Display: see table - View the settings.

• **Description of the display (user interface).**



Icons	Definitions
	Access the User settings
	Use for heating (reference to the circuit concerned Z1 or Z2)
	Use for DHW
	Use for cooling (reference to the circuit concerned Z1 or Z2)
	Stand-by ⁽¹⁾
	Compressor operation
	Electrical back-up operation (heating or DHW)
PROG	PROG mode: Controlled operation ⁽²⁾ according to the: - programme set in the User interface or - programme set on the room thermostat
ECO	Constant mode (with reduced temperature setpoint)
or	Constant mode for heating or cooling (with comfort temperature setpoint)
	Holiday mode (heating only)
OFF	The use concerned is in Off mode (area 1 / 2 - DHW)
	Read information
	Access the Installer settings

⁽¹⁾ Frost protection provided that the electric power supply to the HP is not switched off.

⁽²⁾ If the installation is equipped with a room thermostat, the programme is exclusively managed on the room thermostat.

3.2 Commissioning the appliance

- The installation and first commissioning of the heat pump must be performed by a qualified installer. This person will also instruct you on how to start and run the heat pump.
- Ensure that the installation is correctly filled with water and properly drained and that the pressure measured by the pressure gauge is sufficient (1 to 1.5 bar).
- Close the installation's main circuit breakers.
 - In winter, or after long shutdown periods, close the installation's main circuit breakers (power supply to the outdoor unit) a few hours before activating the heating demand to allow the compressor to pre-heat.

3.3 Commissioning WITHOUT room thermostat

Once your installer has commissioned your installation:

- Set the current date and time (see § 3.3.2).
- Select the programming mode for heating (and for cooling if your installation is equipped with the cooling kit) (see § 3.3.3, page 10).
- Set the temperature setpoints where necessary (see § 3.3.4, page 12).
- Select the DHW programming mode (if the installation is equipped with a domestic hot water tank and electrical back-up) (see § 3.4, page 14).

3.3.1 Basic display

The basic display on the user interface informs the user of the main activity of the HP in progress.

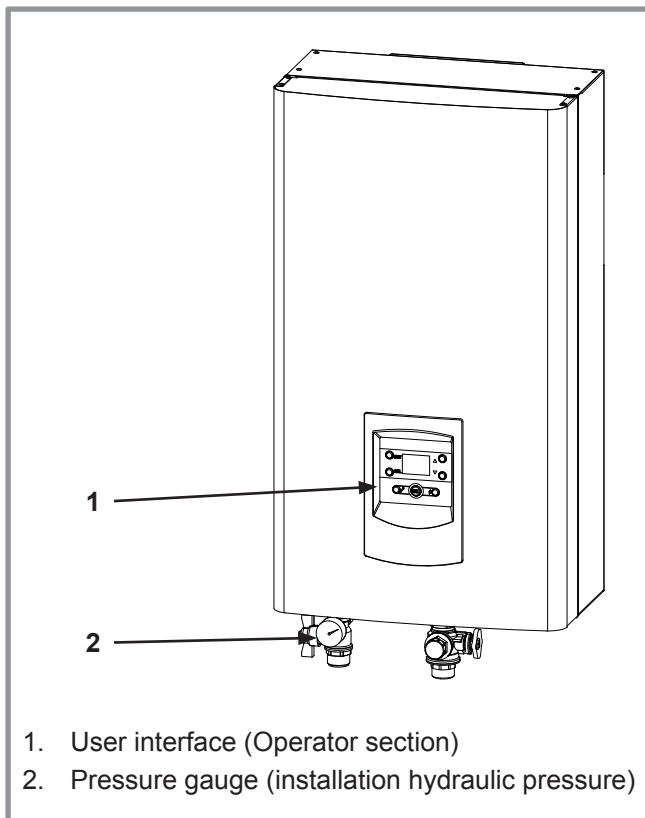

1. User interface (Operator section)
2. Pressure gauge (installation hydraulic pressure)

figure 3 - Loria 6000

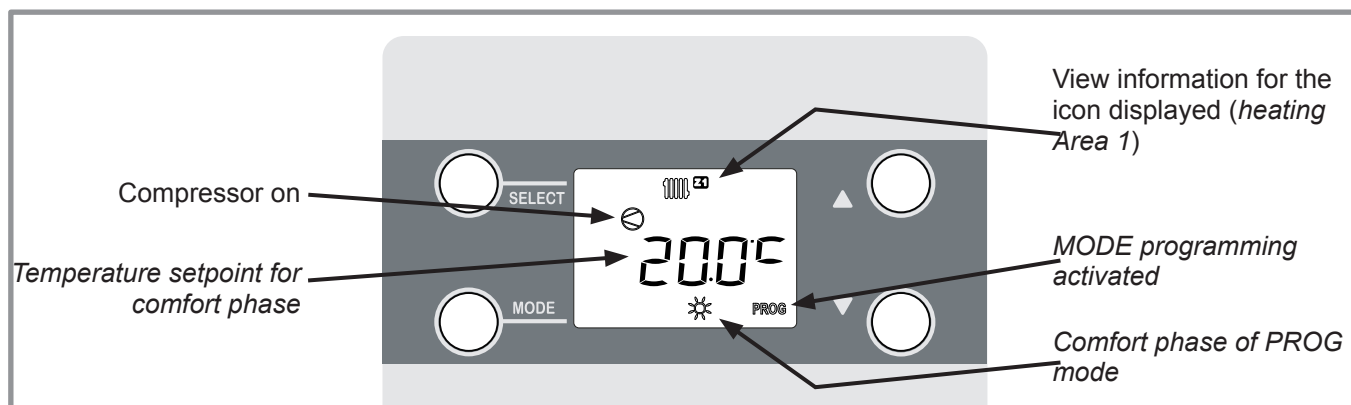
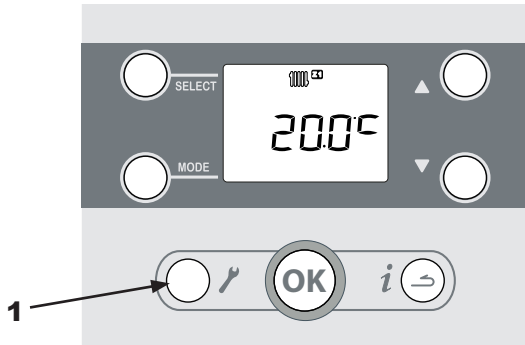

figure 4 - User interface (example of basic display)

3.3.2 Time setting



Basic display.

1 - Press

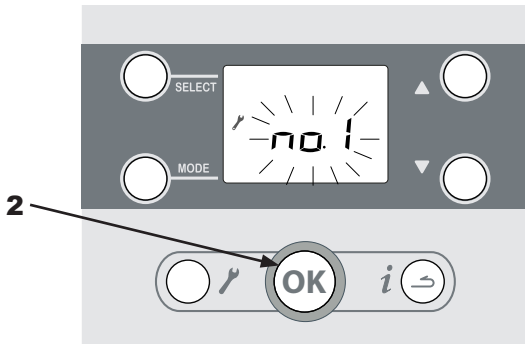

- The "key" icon appears,
- Alternation between the "time settings" parameter (line No. 1) and the time (e.g. 18:30)
(NO. 1 / 18:30):

2 - Press to change the time.

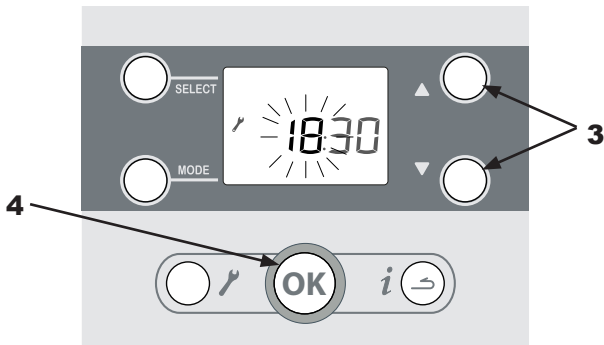

- The hour display flashes.

3 - Press the or button to set the hour.

4 - Press to confirm.

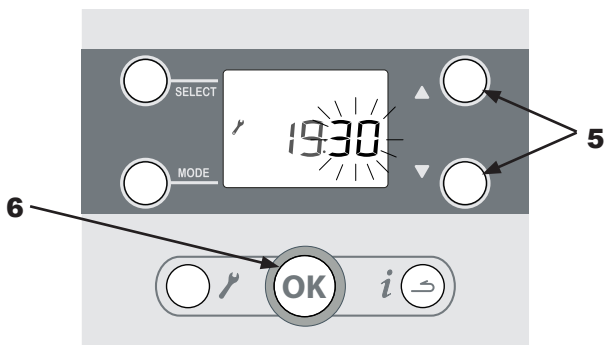

The minutes display flashes.

5 - Press the or button to set the minutes.

6 - Press to confirm.

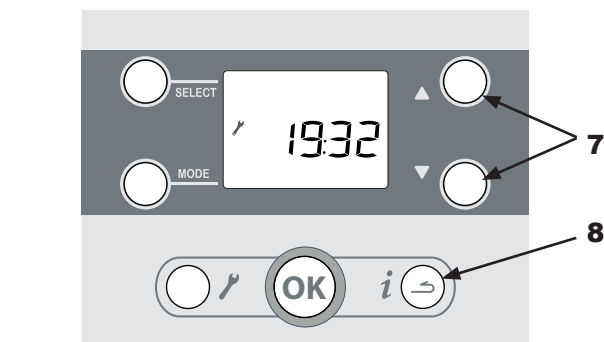

- The settings are saved.

7 - Press the or button to change other settings.

or the

8 - Press to return to the basic display.

3.3.3 Selecting the MODE and setting the TIME PROGRAMME depending on the USE

• Selecting the USE

To select the **use**: press the SELECT button several times.

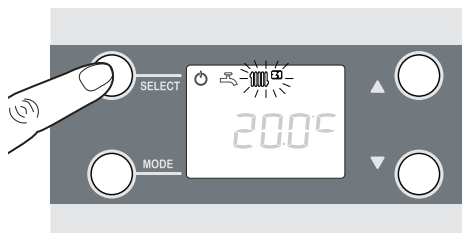

Select the use to be configured. The icon flashes.

Example:

Heating of area 1.

Description of the other **uses***:

Heating of area 2.

Cooling of area 1.

Cooling of area 2.

DHW heating (see [page 14](#)).

• Selecting the MODE

To select the **mode**: press the MODE button several times.

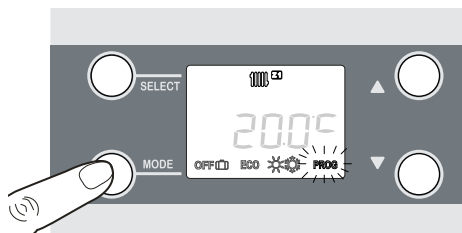

Selecting the desired mode (for the use displayed)

OFF ECO PROG

PROG "PROG" mode: Automatic switching comfort <-> reduced heating depending on the time programme.

Description of the other **modes***:

or constant comfort mode (heating or cooling*).

ECO Constant reduced mode.

Holiday mode.

OFF Off mode (for the use concerned).

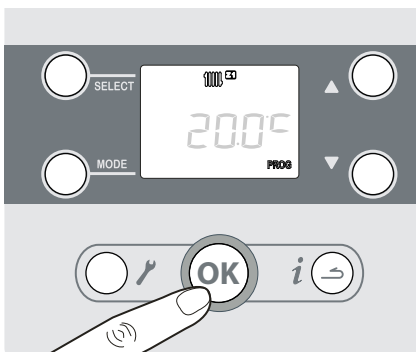

Confirming the adjustment

Press

Note: When browsing, the temperature setpoints can be modified at any time using the ▲ or ▼ buttons. Press

to confirm. Before exiting, check that you have confirmed the desired mode.

* Optional

• Changing the heating (or cooling*) TIME PROGRAMME

The default heating time programme is set for the whole week:

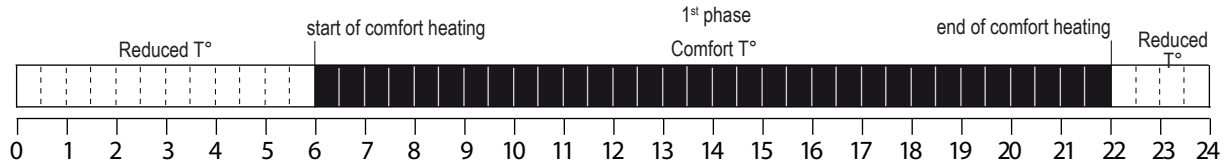

from 6 a.m. to 10 p.m. in comfort mode (from 10 p.m. to 6 a.m. in reduced mode).

































For your comfort you can set up to 3 heating phases and apply these over different time periods (week, day etc.).

- Example: ➤ Monday to Friday [set parameter 11 to 8] (see table)
 - 3 phases [6 a.m.-8 a.m. / 11:30 a.m.-1:30 p.m. and 5 p.m.-10:30 p.m.] (set parameters 12 to 17, see table),
 - Saturday [set parameter 11 to 6] (see table)
 - 2 phases [6 a.m.-8 a.m. / 11:30 a.m.-10:30 p.m.] (set parameters 12 to 15),
 - Sunday
 - 1 phase identical to the default setting [6 a.m.-10 p.m.] (no modifications required).

- On the user interface:

- Press the  button to enter the "user" level: the  icon is displayed.

Selecting the parameter		Settings	
	No. 11 		Select the day(s): 1: Monday, 2: Tuesday, 3: Wednesday, 4: Thursday, 5: Friday, 6: Saturday, 7: Sunday 10: Mon-Sun, 8: Mon-Fri, 9: Sat-Sun, E.g.: 8 (Monday to Friday) 
	No. 12 		start of comfort heating: Start-up time for the 1 st heating phase. E.g.: 06:00 
	No. 13 		end of comfort heating: Shutdown time for the 1 st heating phase. E.g.: 08:00 
	No. 14 		start of comfort heating: Start-up time for the 2 nd heating phase. E.g.: 11:30 
	No. 15 		end of comfort heating: Shutdown time for the 2 nd heating phase. E.g.: 13:30 
	No. 16 		start of comfort heating: Start-up time for the 3 rd heating phase. E.g.: 17:00 
	No. 17 		end of comfort heating: Shutdown time for the 3 rd heating phase. E.g.: 22:30 
- Continue programming for another day (No. 11)... or  - Press  to return to the basic display.			

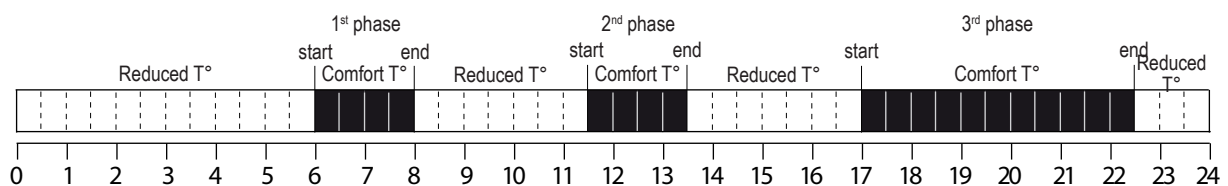

• Use the same procedure to programme the time:

- for area 2* (Circuit 2 time programme) No. 18 to 24,
- for domestic hot water* (DHW time programme) No. 25 to 29 see [page 14](#)),

* Optional

3.3.4 Setting the temperature setpoints

- A - Change the **mode** setpoint.

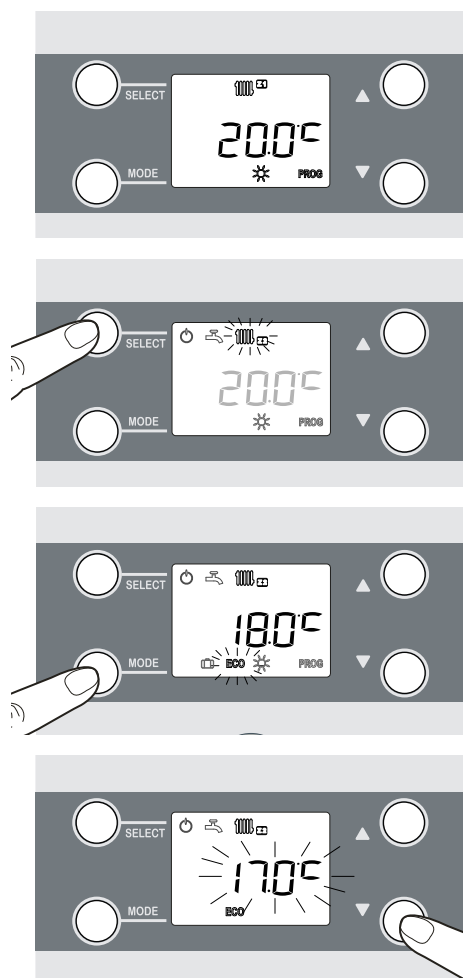

Example: changing the ECO setpoint.

Current use (heating of area 1).

Current mode (PROG / comfort phase).

- If necessary, press the SELECT button to display the **use** to be changed.



[E.g.: Change the setpoint for the area 2 heating use]

- Press the MODE button to display the setpoint to be changed.

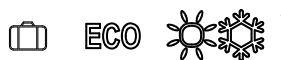

[E.g.: The ECO setpoint is set to 18 °C]

- Set the temperature setpoint using the following buttons:

▲ to increase the setpoint.

▼ to decrease the setpoint.

[E.g.: 17 °C]

- Press  to confirm.

- Press  to return to the basic display.

- B - Specific case: direct access to the current **mode** and **use** setpoints.

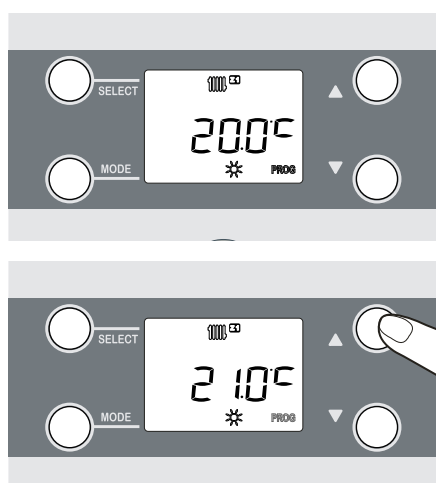

E.g.:

Current use (heating of area 1).

Current mode (PROG / comfort phase).

[The current setpoint (comfort) is 20 °C]

- Set the temperature setpoint using the following buttons:

▲ to increase the setpoint.

▼ to decrease the setpoint.

[E.g.: 21 °C]

- Press  to confirm.

* Optional

3.4 Selecting the DHW* MODE and setting the DHW TIME PROGRAMME

• Selecting DHW USE

To select the **use**: press the SELECT button several times.

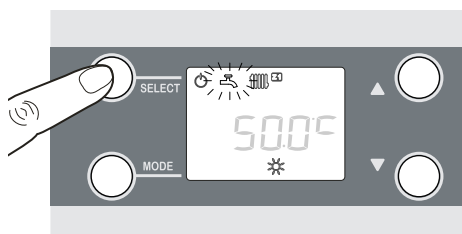

The icon flashes.



• Selecting the MODE

To select the **mode**: press the MODE button several times.

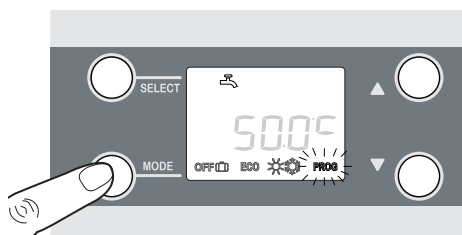

The icon flashes.

OFF ECO  PROG

PROG "PROG" mode: Automatic switching comfort <-> reduced heating depending on the time programme.

Description of the other **modes**:

 Constant comfort mode.

ECO Constant reduced mode.

OFF Off mode (for DHW).

Confirming the adjustment

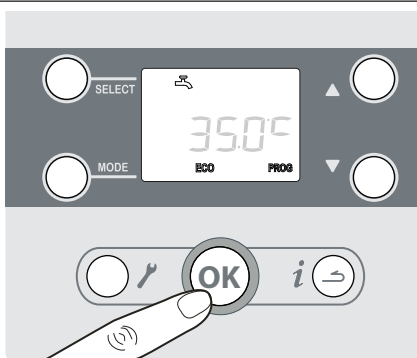

Press 

Notes:

- When browsing, the temperature setpoints can be modified at any time using the ▲ or ▼ buttons. Press  to confirm. Before exiting, check that you have confirmed the desired mode.
- In the event of extreme outdoor temperatures, the electrical back-up system of the DHW tank must be left in operation to guarantee a DHW setpoint greater than 45°C.

* Optional

• Changing the DHW timer programme

The default DHW timer programme is set for the whole week (Monday to Sunday: **10**): from 12 a.m. to 5 a.m. (1st DHW heating phase) and from 2:30 p.m. to 5 p.m. (2nd DHW heating phase).

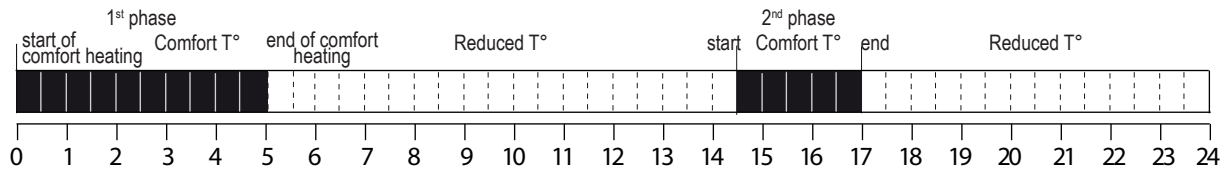

For your comfort you can set up to 2 DHW heating phases and apply these over different time periods (week, day etc.).

- Example : ➤ Monday to Sunday [parameter 25 set to 10] (see table)
- 2 phases [12 a.m.-7 a.m. / 1:30 p.m.-5 p.m. and 5 p.m.-10:30 p.m.] (set parameters 26 to 29, see table),

➤ Press the button to enter the "user" menu: the icon is displayed.

Selecting the line No.	Settings
No. 25	Select the day(s): 10 : Mon-Sun, 8 : Mon-Fri, 9 : Sat-Sun, 1 : Monday, 2 : Tuesday, 3 : Wednesday, 4 : Thursday, 5 : Friday, 6 : Saturday, 7 : Sunday E.g.: 10 (Monday to Sunday)
No. 26	start of comfort heating: Start-up time for the 1st heating phase . E.g.: 00:00
No. 27	end of comfort heating: Shutdown time for the 1st heating phase . E.g.: 07:00
No. 28	start of comfort heating: Start-up time for the 2nd heating phase . E.g.: 13:30
No. 29	end of comfort heating: Shutdown time for the 2nd heating phase . E.g.: 17:00

- Continue programming for another day (line 25).

or
 - Press to return to the basic display.

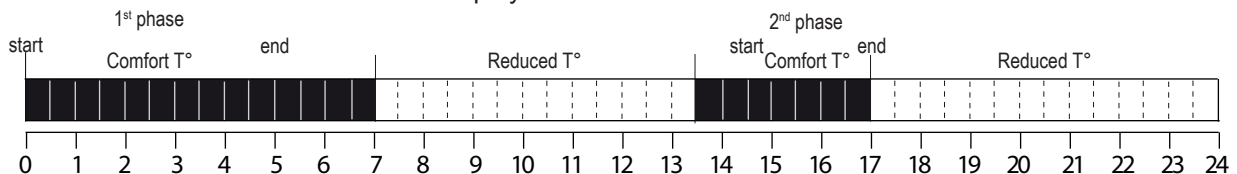

• DHW boost (without room thermostat).

A DHW boost function is available (on the user interface: , parameter **55** - see [page 16](#)). This DHW boost enables the DHW to be heated to the comfort temperature at any time during the day. The boost function is cancelled automatically when the demand for hot water has been met.

• DHW boost (with room thermostat).
 see § 7.2.7, [page 26](#).

4 Regulation parameters

4.1 Overview

• Only the parameters accessible to the following level:



are described in this document.

• The parameters accessible to the following level:



... are described in the document reserved for these professional specialists. **Do not make any modifications to these parameters without advice**

from these professional specialists.

4.2 Setting parameters on the user interface

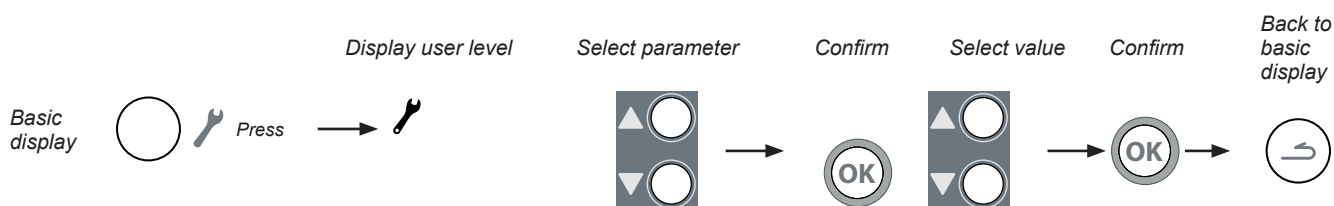

















If no setting is made for 15 minutes, the screen automatically returns to the basic display.

4.3 List of "End User" parameters

No.	Function	Configuration or display range	Basic setting
Time / Date setting			
1	Hours / minutes	00:00... 23:59	01:00
2	Day of Week	1... 7 (1 = Monday; 2 = Tuesday...; ... 7 = Sunday)	-
Heating time programme ⁽²⁾, circuit 1			
11	Pre-selection (day / week)	1 ... 10	-
1 = Monday; 2 = Tuesday... 7 = Sunday; 8 = Monday to Friday; 9 = Saturday and Sunday 10 = Monday to Sunday (modifications are applied to the whole week)			
12	1 st phase of the selected day (start of comfort)	00:00... 23:45	06:00
13	1 st phase of the selected day (end of comfort)	00:15... 24:00	22:00
14	2 nd phase of the selected day (start of comfort)	00:00... 23:45	--:--
15	2 nd phase of the selected day (end of comfort)	00:15... 24:00	--:--
16	3 rd phase of the selected day (start of comfort)	00:00... 23:45	--:--
17	3 rd phase of the selected day (end of comfort)	00:15... 24:00	--:--

⁽¹⁾ These parameters (or menus) may not appear. They depend on the appliance's configuration (on the options selected).

⁽²⁾ With a room thermostat, these menus are not shown on the user interface. The time programme is only managed using the room thermostat in the area considered.

No.	Function	Configuration or display range	Basic setting
Heating time programme ^{(1) (2)}, circuit 2			
18	 Pre-selection (day / week)	1 ... 10	-
	1 = Monday; 2 = Tuesday... 7 = Sunday; 8 = Monday to Friday; 9 = Saturday and Sunday 10 = Monday to Sunday (modifications are applied to the whole week)		
19	 1 st phase of the selected day (start of comfort)	00:00... 23:45	06:00
20	 1 st phase of the selected day (end of comfort)	00:15... 24:00	22:00
21	 2 nd phase of the selected day (start of comfort)	00:00... 23:45	- :- -
22	 2 nd phase of the selected day (end of comfort)	00:15... 24:00	- :- -
23	 3 rd phase of the selected day (start of comfort)	00:00... 23:45	- :- -
24	 3 rd phase of the selected day (end of comfort)	00:15... 24:00	- :- -
DHW timer programme ⁽¹⁾			
25	 Pre-selection (day / week)	1 ... 10	-
	1 = Monday; 2 = Tuesday... 7 = Sunday; 8 = Monday to Friday; 9 = Saturday and Sunday 10 = Monday to Sunday (modifications are applied to the whole week)		
26	 1 st phase of the selected day (start of comfort)	00:00... 23:45	00:00
27	 1 st phase of the selected day (end of comfort)	00:15... 24:00	05:00
28	 2 nd phase of the selected day (start of comfort)	00:00... 23:45	14:30
29	 2 nd phase of the selected day (end of comfort)	00:15... 24:00	17:00
Heat pump			
45	 Switch from summer/winter (according to the outdoor temperature)	15... 30 °C	18 °C
	When the average of the outdoor temperatures reaches 18°C, the regulator switches off the heating (as an economy measure).		
46	 Legionella function ⁽¹⁾	0 (off)... 1 (on)	0
47	 Correction of outdoor temperature sensor	- 5... 5 °C	-
49	 Assist mode	0 (Assist mode off)... 1 (Assist mode on)	0
55	 DHW boost ⁽¹⁾	0 (off)... 1 (on)	0

⁽¹⁾ These parameters (or menus) may not appear. They depend on the appliance's configuration (on the options selected).

⁽²⁾ With a room thermostat, these menus are not shown on the user interface. The time programme is only managed using the room thermostat in the area considered.

5 Information and troubleshooting

5.1 Displaying information

The  button calls up various information.



Depending on the appliance type, the configuration and the state of operation, certain information lines may not be available.

The information number is displayed and alternates with its value.

 No...	Name	Value...
1	Time.	hh:mm
2	Outdoor temperature.	... °C
3	Circuit 1: Initial temperature.	... °C
4	Circuit 1: Initial setpoint.	... °C
5	Return temperature.	... °C
6	Flow measurement.	... l/min
7	Compressor modulation level (%).	... %
8	Heating back-up status.	0 = off 1 = on
9	Circuit 2: Initial temperature.	... °C
10	Circuit 2: Initial setpoint.	... °C
11	DHW temperature.	... °C
12	DHW setpoint.	... °C
13	HP status.	see details § "Status list"
14	Heating circuit 1 status.	
15	Heating circuit 2 status.	
16	DHW circuit status.	
17	DHW back-up status.	0 = off 1 = on
18	Outdoor unit error code (see details in table page 20).	

Status list

The parameter number is displayed and alternates with its value (example No. 13 / 1 = HP heating status).

 No.	Value...	HP status
13	0	Pending.
	1	Heating.
	2	Cooling.
	3	Error.
	4	Assist mode.
	5	Locked.
	6	Defrost activated.
7	Test mode.	
 No.	Value...	Heating circuit 1 and 2 status
14 & 15	0	Pending.
	1	Comfort heating mode.
	2	Reduced heating mode.
	3	Comfort cooling mode.
	4	Reduced cooling mode.
	5	Holiday mode.
	6	Controlled by the room thermostat.
	7	Frost protection activated.
	8	Floor drying mode.
9	Rate input activated.	
 No.	Value...	DHW status
16	0	Pending.
	1	Comfort mode, charge activated.
	2	Reduced mode, charge activated
	3	Legionella charge.
	4	Frost protection activated.
5	Forced operation.	

5.2 Hydraulic unit errors

The faults or breakdowns of the hydraulic unit are reported on the display unit of the user interface. The display shows the "ERXXX" error code. A minor error does not result in switching the appliance to safety mode (if in doubt on the reasons for the malfunction or if the problem persists, contact your installer). A major error results in switching the appliance to safety mode. Note the code and contact your installer.



Error codes		Description	Switched to safety mode	Probable causes
Minor error	Major error			
3	-	Hydraulic flow rate too low.	-	Circulation pump speed settings too low. Clogged filtering component.
-	131		(Appliance shutdown if the error 3 occurs 3 times in 1 hour)	
5	-	Initial temperature (T5) or return temperature (T6) < 2 °C	-	Frost protection function defective. Back-up disconnected.
6	-	Communication error between the interface board and the HP regulator board.	-	Check the wiring.
19	-	Test mode activated.	-	-

 Always check that the electric power supply is switched off before maintaining the boiler.

Error codes		Description	Switched to safety mode	Probable causes	
Minor error	Major error				
35	-	HP outgoing flow sensor error (T5).	-	Short circuit, sensor disconnected or cut off. Defective sensor. Other error.	
36	-	HP return flow sensor error (T6).	-	Short circuit, sensor disconnected or cut off. Defective sensor. Other error.	
-	132	Initial temperature > 70 °C (T5)	-		
46	-	Circuit 2 sensor error (T12)	-	Short circuit, sensor disconnected or cut off. Defective sensor. Other error.	
48	-	Outdoor temperature sensor error (T7)	-	Short circuit, sensor disconnected or cut off. Defective sensor. Other error.	
47	-	DHW tank sensor error (T8)	-	Short circuit, sensor disconnected or cut off. Defective sensor. Other error.	
-	148	Legionella cycle error	This error appears if 3 consecutive tests fail.	DHW back-up disconnected.	
52	-	Frost detected on the return circuit when defrosting the outdoor unit (temperature < 2 °C).	-	Circulating water volume too low (contact installer).	
-	180		Appliance shutdown if the error 52 occurs 3 times in 1 hour.		
53	-		Frost detected on the outgoing circuit when defrosting the outdoor unit (temperature < 3 °C).		-
-	181	Appliance shutdown if the error 53 occurs 3 times in 1 hour.			
55	-	Frost protection of the HP circuit activated (with electrical back-up)	-	-	
56	-	Frost protection of the DHW tank activated (with electrical back-up)	-	-	
62	-	Load shedding - peak shaving or rate input activated	-	-	
66	-	Outdoor unit error (external cause)	-	See § "5.3 Outdoor unit errors", page 20.	
67	-	DHW cycle too long (> 6 hours).	-	Too much draw-off during the same cycle. DHW back-up disconnected.	
-	195		Appliance shutdown if the error 67 occurs 3 consecutive times.		
68	-	Room temperature in area 1 missing when the "room T° influence" function (No. 33) is activated.	-	Parameter 33 used without room unit. Room unit disconnected or absent.	
69	-	Room temperature in area 2 missing when the "room T° influence" function (No. 41) is activated.	-	Parameter 41 used without room unit. Room unit disconnected or absent.	
70	-	Assist mode activated.	-	-	
71	-	Circuit temperature 2 > 55 °C	-	Defective mixing valve.	
73	-	External error linked to input EX3.	Parameter 56 set to ...	Outdoor component error.	
					1 -> HP locked
					2 -> Area 1 shut down 3 -> Area 2 shut down
76	-	Low hydraulic flow rate.	-	Circulation pump speed settings too low. Clogged filtering component.	

5.3 Outdoor unit errors

In the event of an outdoor unit error:

- The user interface displays the error code "Er 66".
- View the information menu  , 
- Information " *i* No. 18" specifies the error code for the outdoor unit " *i* xx" (list provided below).

Outdoor unit error code	Interface board		Outdoor unit board	Error contents
	LED (green) ²	LED 1 (red)	LED	
0	1 Flash	1 Flash	Off	Communication error between the interface board and the outdoor unit: transfer error (Serial reverse).
1			1 Flash	Communication error between the interface board and the outdoor unit: transfer error (Serial forward).
2	4 Flashes	2 Flashes	22 Flashes	Hydraulic unit exchanger temperature sensor error.
3	6 Flashes	3 Flashes	18 Flashes	Inverter error.
4	6 Flashes	4 Flashes	19 Flashes	Active filter error / PFC error
5	7 Flashes	1 Flash	2 Flashes	Discharge temperature sensor error.
6	7 Flashes	2 Flashes	8 Flashes	Compressor temperature sensor error.
7	7 Flashes	3 Flashes	5 Flashes	Exchanger temperature sensor (centre) error.
8			4 Flashes	Exchanger temperature sensor (output) error.
9	7 Flashes	4 Flashes	7 Flashes	Outdoor temperature sensor error.
10	7 Flashes	7 Flashes	9 Flashes	Radiator temperature sensor (inverter) error.
11			10 Flashes	Radiator temperature sensor (P.F.C.) error.
12	7 Flashes	8 Flashes	6 Flashes	Pressure regulator temperature sensor error.
13	8 Flashes	4 Flashes	-	Current current error.
14	8 Flashes	6 Flashes	3 Flashes	Pressure sensor error / pressure switch error.
15	9 Flashes	4 Flashes	13 Flashes	Current sensor error (permanent shutdown).
16	9 Flashes	5 Flashes	14 Flashes	Detection error for the position of the compressor rotor (permanent shutdown).
			15 Flashes	Compressor start-up error (permanent shutdown).
17	9 Flashes	7 Flashes	16 Flashes	Outdoor unit fan motor 1 error.
			17 Flashes	Outdoor unit fan motor 2 error.
18	10 Flashes	1 Flash	11 Flashes	Discharge temperature protection (permanent shutdown).
19	10 Flashes	3 Flashes	12 Flashes	Compressor temperature protection (permanent shutdown).
20	10 Flashes	5 Flashes	20 Flashes	Abnormal low pressure.
21	Depending on the outdoor unit error			Error originating from the outdoor unit.
22	3 Flashes	2 Flashes	-	Communication error between the interface board and the HP regulator board.

☞ Always check that the electric power supply is switched off before maintaining the boiler.

6 Maintenance

To ensure that your device works properly for many years, the following maintenance operations should be performed at the start of each heating season. Generally, these are performed as part of a service contract.

6.1 Regular checks

- Periodically check the water pressure in the heating circuit (refer to the pressure level recommended by the installer - between 1 and 2 bar).
- If you need to fill up and reset the pressure, check the type of fluid originally used (if in doubt, contact your installer).

☞ If frequent refills are required it is essential that you look for any leaks.

☞ **The frequent supply of water risks causing scale to build up within the heat exchanger and degrade its performance and life.**

- If error **Er 76** is displayed: Call your installer.

6.2 Outdoor unit check

Remove any dust from the exchanger making sure you do not damage the blades.

Check that there is nothing hindering the air flow.

7 Room thermostat UA55 (optional)

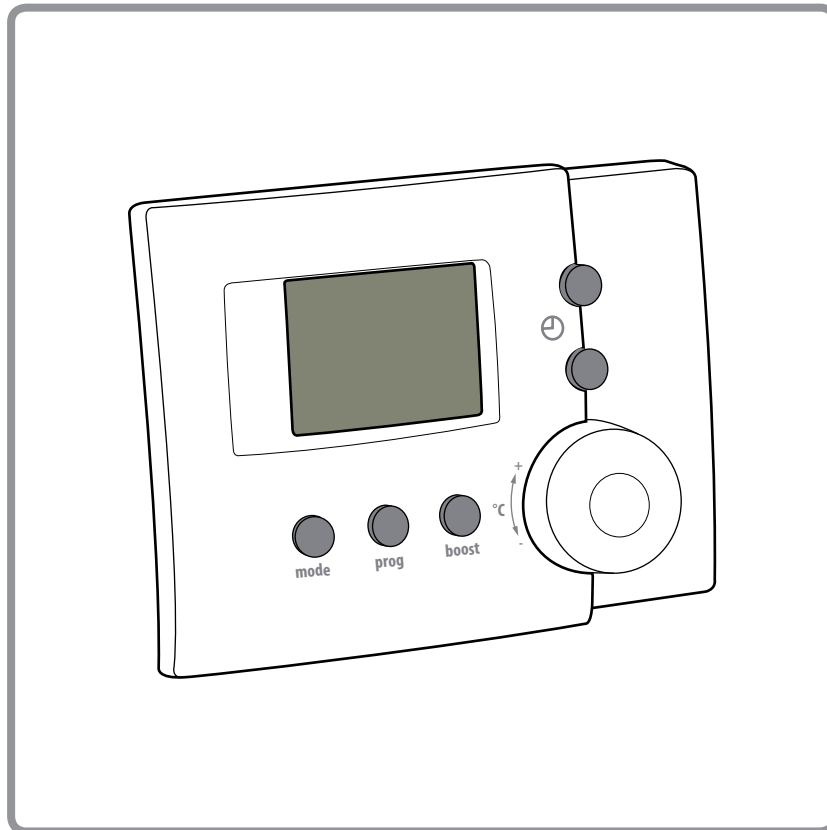

7.1 Room thermostat* and description of the display

If the installation is equipped with a room thermostat, the time programme does not appear on the user interface. The time programme is only managed using the room thermostat in the area considered. Refer to the room thermostat instruction manual.

Description of the display:

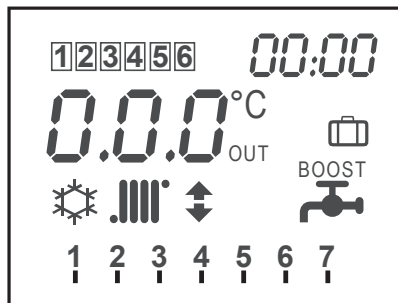

Icons	Definitions
	Heating indicator
	DHW indicator*
	Cooling indicator*
	Configuration in progress (the icon and values to be changed flash).
BOOST	Exemption (Heating or DHW*)
	Holiday mode
0.0.0	Display: Temperature / Setpoint value / Error codes
OUT	Outdoor indicator (temperature)
18:30	Time display
1 2 3 4 5 6	Programme time slots (6 phases maximum)
1 2 ... 7	Day of the week (1 = Monday, ... 7 = Sunday)

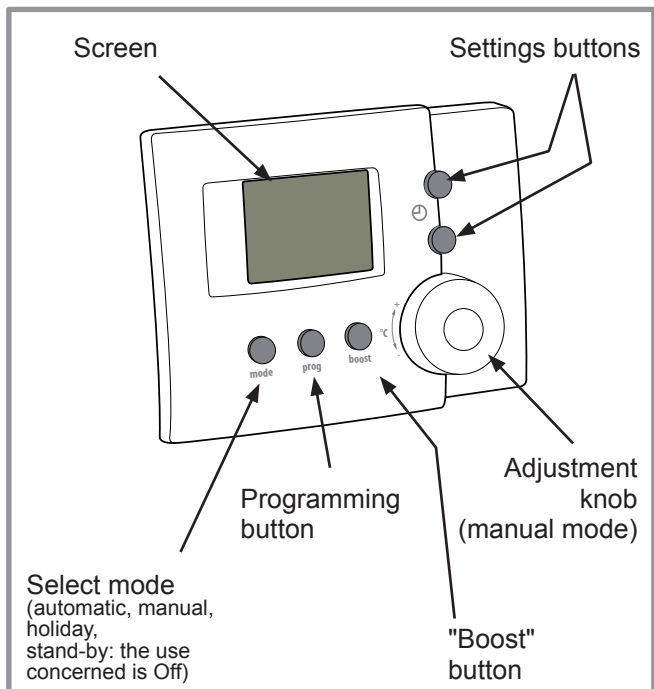

figure 5 - Room thermostat (optional)

7.2 Commissioning WITH room thermostat

Once your installer has commissioned your installation:

On the room thermostat:

- Set the current date and time (see § 7.2.1, page 23).
- Select the automatic mode for heating (and for cooling if your installation is equipped with the cooling kit) (see § 7.2.3, page 24).

On the user interface:

If the installation is equipped with a DHW tank with electrical back-up:

- Select the programming mode for the DHW (see § 3.4.4, page 14).

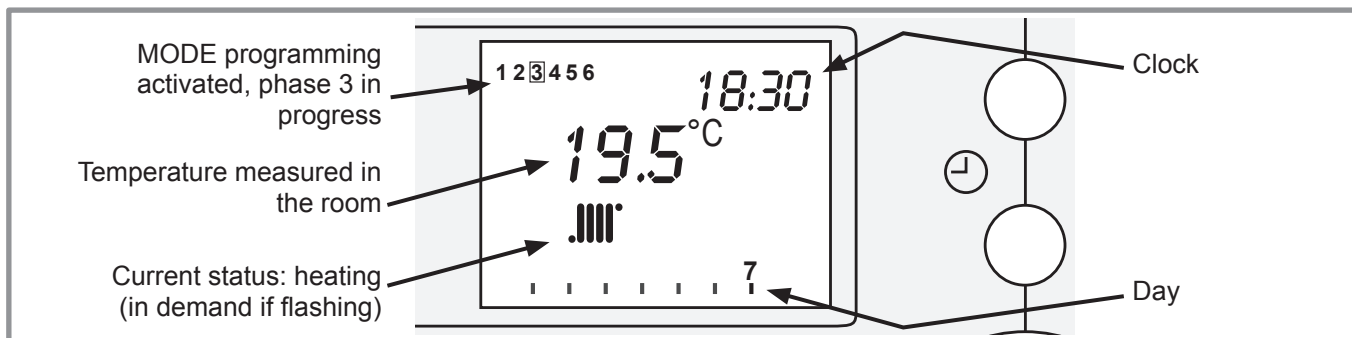
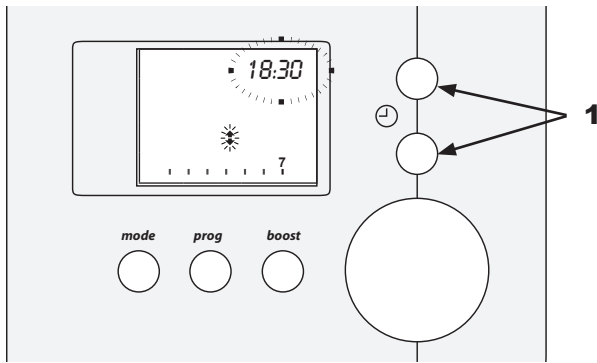

figure 6 - Room thermostat (example of basic display)

* Optional

7.2.1 Setting the time and day



Basic display.

Setting the time

- 1** - Press or to reach the time and day settings menu,

- The hour display flashes.

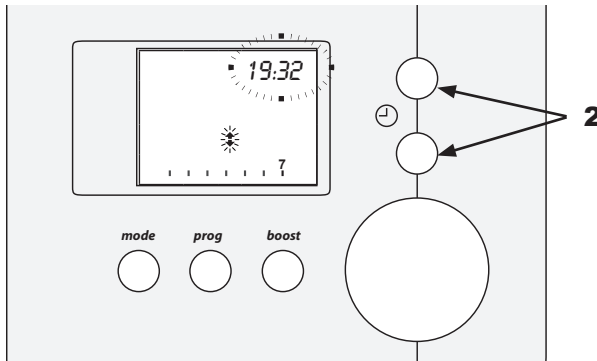

- 2** - Press or to set the time

[e.g. 6:30 p.m. -> 7:32 p.m.],

(press and hold the key to accelerate the setting process).

Follow the method below to set the day...

Setting the day

(The time display flashes; if not, repeat No. **1**).

- 3** - Press the **prog** button to access the day setting (1: Monday... 7: Sunday).

- The day display flashes.

- 4** - Press or to change the day

[e.g. Tuesday -> set 2].

- 5** - To save the data and exit the settings menu, press the adjustment knob.

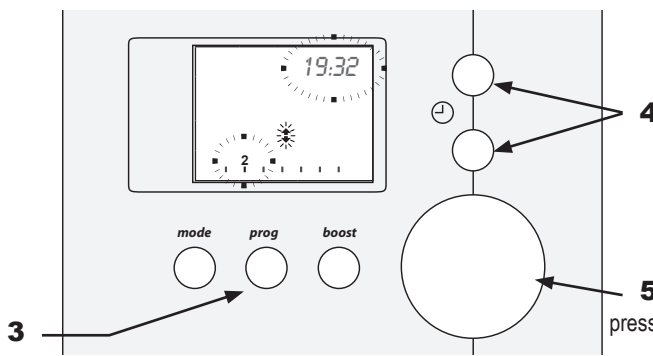

7.2.2 Mode selection

Selecting the MODE.

- To select the mode: press the MODE button several times:

<p>- Automatic mode (temperature set according to the time programme) see § 7.2.3, page 24.</p>		<p>- Holiday mode (temperature set for a given number of days) see § 7.2.5, page 25.</p>	
<p>- Constant mode (steady, constant temperature) see § 7.2.4, page 25.</p>		<p>- Standby mode (heating / cooling*): off see § 7.2.6, page 26.</p>	

- Press and "hold" the **mode** button for more than 3 seconds to select the status (heating or cooling*).

The current status is shown via the icon (heating) or icon (cooling*).

7.2.3 Automatic mode: setting the TIME PROGRAMME and the temperature setpoint

- The **default time programme** is set ➤ for the whole week [Day 1 to 7]

➤➤ 6 phases: [6 a.m. (20 °C)] - [8 a.m. (18 °C)] - [11:30 a.m. (20 °C)] - [1:30 p.m. (18 °C)] - [5:00 p.m. (20 °C)] and [10 p.m. (18 °C)].

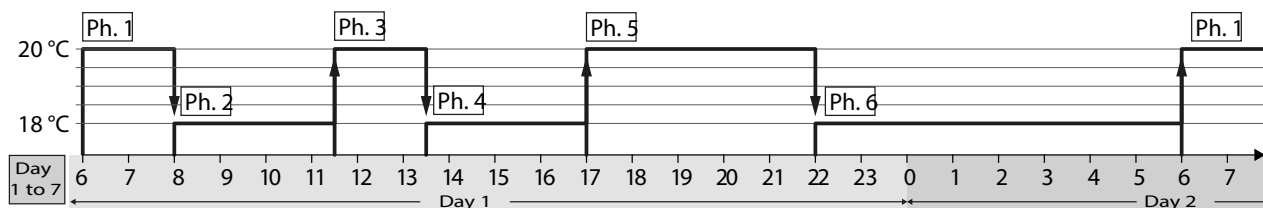

- **Changing the standard programme:** The programme can be adapted to suit individual needs (either for all days or individually per day of the week), with a maximum of 6 time slots.

Each phase is defined by a **start-up time** and a **room temperature**.

At least one phase must be activated.

Example changing the time programme for the weekend ➤ Saturday to Sunday [Day 6 and 7]:

➤➤ 2 phases [7:30 a.m. at 20.5 °C] and [11 p.m. at 18 °C].

(In this example, phases 1 and 6 must be modified and phases 2 to 5 must be deactivated).

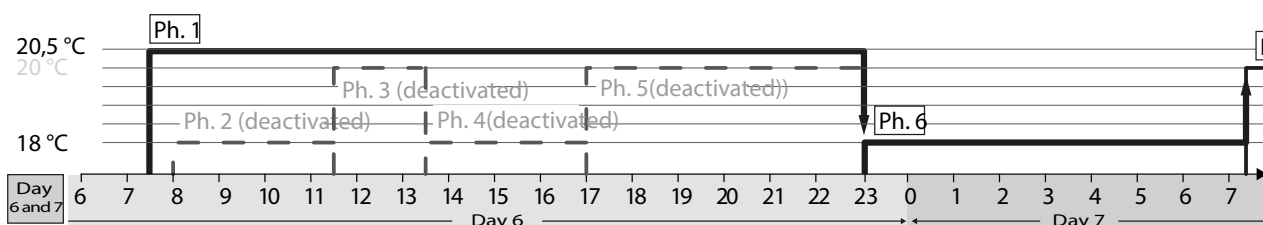



To enter the "programme settings" menu:

- Press the **prog** button.

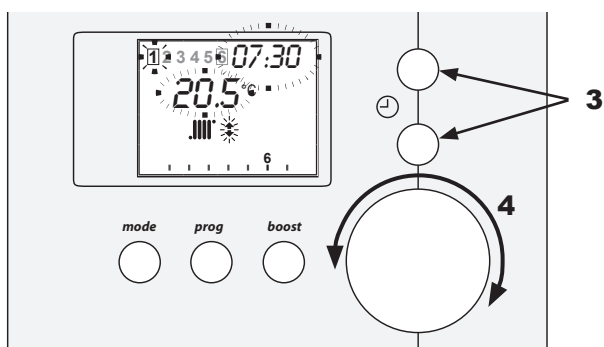
Change the day, phase, time and temperature
(e.g.: setting day 6 - phase 1 - 7:30 a.m. - 20.5 °C).



- 1 - Press the knob to change the day to be programmed [e.g. Saturday: day 6].
- 2 - Press the **prog** button to select the phase to be configured [e.g. phase 1].
- 3 - Press  or  to set the start time [e.g. 7:30 a.m.].
- 4 - Turn the knob to set the desired room temperature [e.g. 20.5 °C].
- 5 - Press the **prog** once to set the next phase. Then follow Nos. 3 and 4 [e.g. Ph. 6 at 18 °C].

Deactivate a phase

(e.g.: day 6 - phase 2 deactivated).

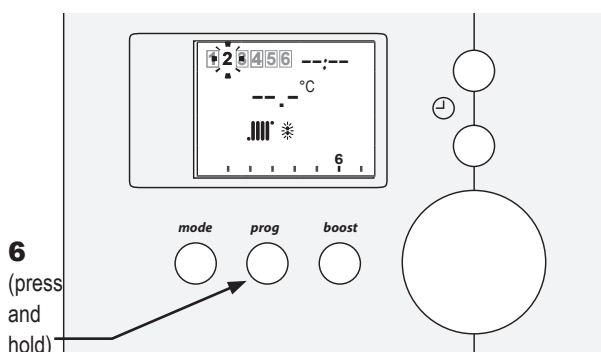

6 - To activate or deactivate the current time programme phase, use the **prog** button (press and "hold" for more than 2 seconds). The current time programme phase is deactivated when "-" is displayed.

[e.g. Ph. 2 to 5].

- 7 - Where necessary, press the knob to configure the next day. Then follow Nos. 2, 3 and 4.

Copy a phase to the next day

tip (e.g.: copy phase 1 - 7:30 a.m. - 20.5 °C to day 7).

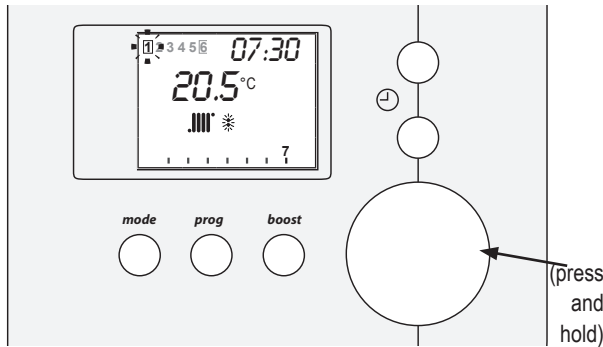

Tip: to copy identical phases:

- Press and "hold" the knob for more than 3 seconds to **copy the time programme phase to the next day.**
[e.g. Sunday: day , 7, phase 1²; 7:30 a.m., 20.5 °C].

To exit the "programme settings" menu:

- Press the **mode** button.
- or, if no setting is made for 1 minute, the screen automatically returns to the basic display.

7.2.4 Constant mode: setting the temperature setpoint

(e.g.: set setpoint to 22 °C).

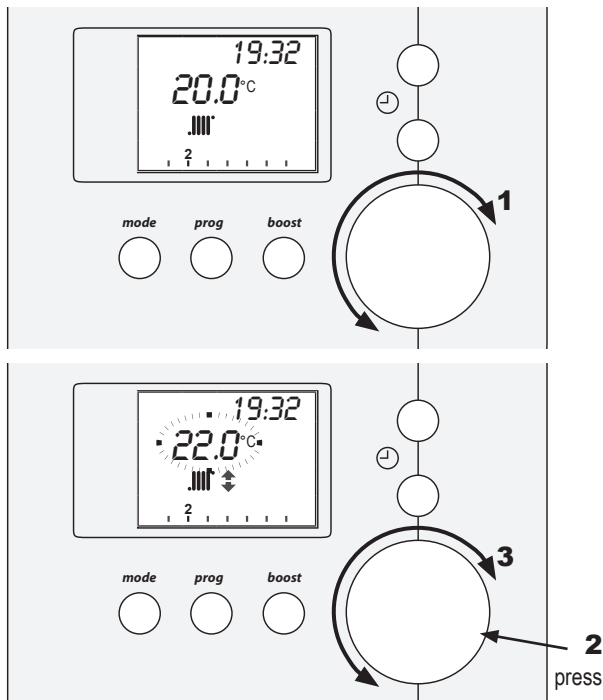

(e.g.: default display).

Reminder: the default temperature displayed corresponds to the temperature measured in the room) (e.g. 19.5 °C).

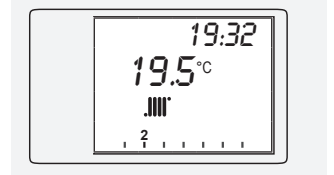

1 - Turn the knob to set the initially recorded setpoint [e.g. 20 °C].

2 - Press (the t° flashes) then turn the knob (**3**) to set the desired room temperature [e.g. 22 °C],

4 - Press the knob to confirm.

The display returns to the temperature measured in the room and to constant mode.

Note: if this setting is made when the sensor is in automatic mode, it will be cancelled and replaced with manual mode.

7.2.5 Holiday mode

(e.g.: set 9 days of absence at 14 °C).

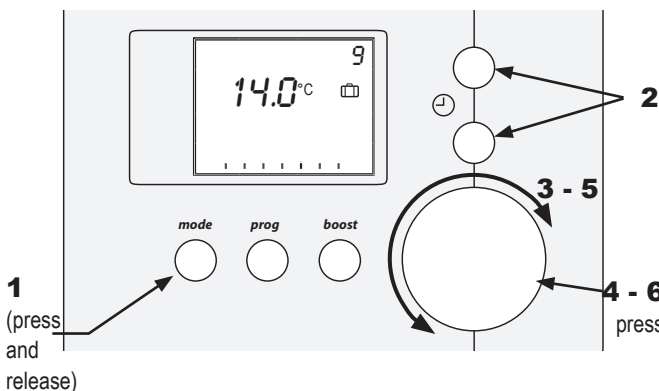

1 - Press the **mode** button to select the holiday mode (until the suitcase icon appears).

2 - Press or to set the number of days [e.g. 9].

3 - Turn the knob to set the initially recorded setpoint.

4 - Press then turn the knob (**5**) to set the desired temperature [e.g. 14 °C],

6 - Press the knob to confirm.

7.2.6 Standby mode

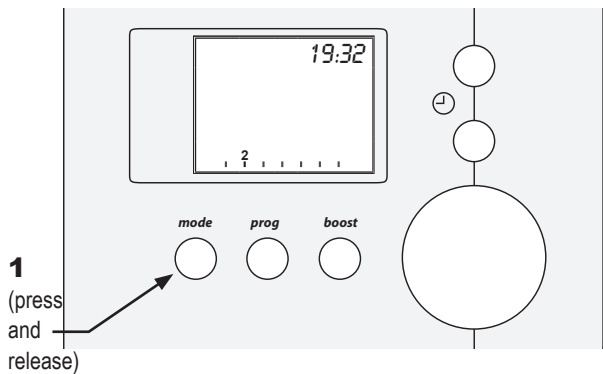

1 - Press the **mode** button to select the standby mode (until all icons disappear).

7.2.7 Exemption function – "Boost" button

(e.g.: heating exemption).

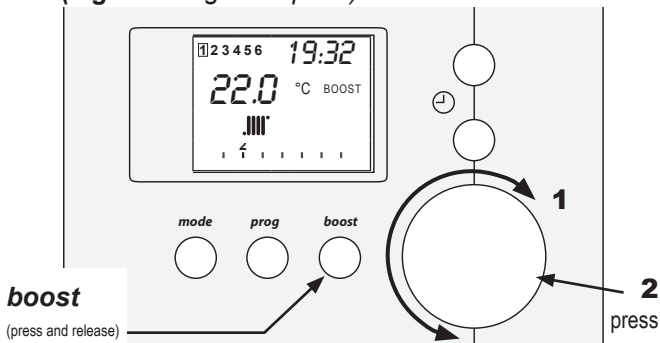

Press the **boost** button to access the exemption functions.

- **Press and release:** heating (or cooling*) exemption activated. The "BOOST" text appears on the screen.

When the exemption is activated, the room temperature must be set using the knob (**1**) (e.g. 22°C). Press the knob (**2**) to confirm.

In Auto mode, the exemption stops when the next time programme phase begins.

In manual mode, the exemption applies for 2 hours, then stops.

(e.g.: DHW* "boost")

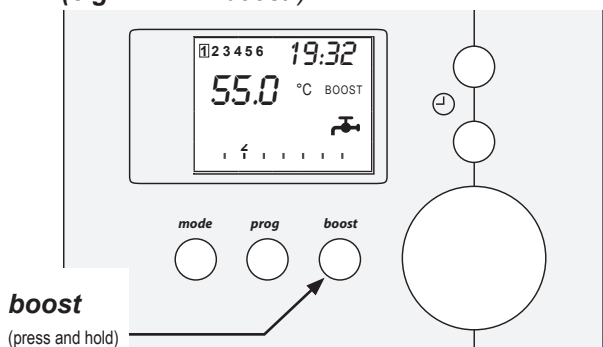

- **Press and hold (> 3 secs):** DHW* "Boost" activated. The "BOOST" text and the tap* icon are displayed on the screen.

The DHW tank is heated to reach the comfort setpoint.

(e.g. info: outdoor temperature reading).

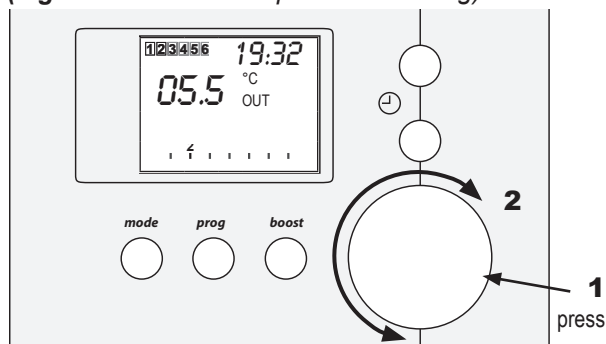

7.2.8 Information screen – Knob button

In automatic mode or standby mode:

The information screen can be accessed by pressing the knob (**1**); turn the knob (**2**) to access the following information:

- Outdoor temperature.
- Circuit temperature (heating / cooling*).
- Temperature of the domestic hot water tank*.
- Holiday settings: number of days.
- Holiday settings: holiday temperature.

Press the **mode** button to exit the information screen.

or, if no setting is made for 1 minute, the screen automatically returns to the basic display.

* Optional

7.3 Appliance shutdown

7.3.1 Stopping heating

In the event of appliance shutdown for a known period of time, set the appliance to **holiday mode**:

- Without room thermostat, see § 3.3.3, *page 10*.
- With room thermostat, see § 7.2.5, *page 25*.

In the event of shutdown for an extended period or an unknown period of time, set the appliance to **off or standby mode**:

- Without room thermostat, see § 3.3.3, *page 10*.
- With room thermostat, see § 7.2.6, *page 26*.

7.3.2 Stopping the DHW*

Set to **off mode**: see § 3.4, *page 14*.

* Optional

8 ERP performance values

8.1 ERP definition

"ERP" includes two European directives that are part of the programme for the global reduction of greenhouse gas emissions:

- The eco-design directive sets efficiency thresholds and prohibits the sale of any product with an efficiency lower than the set thresholds.
- According to the labelling directive, energetic efficiency shall be displayed to encourage end users to purchase energy-efficient products.

8.2 ERP Specifications

Trade name / Product name:	atlantic / ...		Loria 6004		Loria 6006		Loria 6008		Loria 6010	
Reference			522911		522912		522913		522914	
Heating ranges			35°C	55°C	35°C	55°C	35°C	55°C	35°C	55°C
Air/water heat pump			Yes							
Equipped with a supplementary heater			Yes							
Average climate - Space heating characteristics										
Energy class ⁽⁶⁾	-	-	A++	A+	A++	A++	A++	A+	A++	A++
Rated heat output ⁽²⁾	P_{rated}	kW	4	4	6	5	7	6	9	7
Seasonal heating energy efficiency	η_s	%	181	127	186	128	166	125	154	116
Seasonal efficiency for package with outdoor temperature sensor ⁽¹⁾	η_s	%	183	129	188	130	168	127	156	118
Seasonal efficiency with room unit ⁽¹⁾	η_s	%	185	131	190	132	170	129	158	120
Annual energy consumption	Q_{he}	kWh	1884	2708	2588	2933	3226	4197	4481	5256
Colder climate - Space heating characteristics										
Rated heat output ⁽²⁾	P_{rated}	kW	NA							
Seasonal heating energy efficiency	η_s	%								
Annual energy consumption	Q_{he}	kWh								
Warmer climate - Space heating characteristics										
Rated heat output ⁽²⁾	P_{rated}	kW	5	5	6	6	7	7	12	8
Seasonal heating energy efficiency	η_s	%	221	160	242	153	211	154	201	130
Annual energy consumption	Q_{he}	kWh	1270	1793	1201	1936	1866	2349	3040	2990
Acoustic values										
Sound power level of hydraulic unit	L_{WA}	dBa	44		44		44		44	
Sound power level of outdoor unit	L_{WA}	dBa	62		62		69		68	
Declared capacity for heating for part load at indoor temperature 20°C and outdoor temperature Tj										
Tj = -7°C	Pdh	kW	3,7	3,8	5,2	4,1	5,8	5,7	7,5	6,6
Tj = +2°C	Pdh	kW	2,4	2,5	3,5	2,7	3,4	3,4	4,6	4,0
Tj = +7°C	Pdh	kW	2,0	1,4	1,9	1,8	2,5	2,3	3,2	3,2
Tj = +12°C	Pdh	kW	2,3	2,1	2,4	2,1	2,2	2,0	3,8	3,5
Tj = bivalent temperature	Pdh	kW	3,7	3,8	5,2	4,1	5,8	6,3	7,5	6,6
Tj = operation limit temperature	Pdh	kW	3,4	3,2	4,8	3,9	6,0	4,7	6,9	6,1
Bivalent temperature	T_{biv}	°C	-7	-7	-7	-7	-7	-7	-7	-7
Degradation coefficient (3) ⁽³⁾	Cdh	-	0,9	0,9	0,9	0,9	0,9	0,9	0,9	0,9
Declared coefficients of performance for part load at indoor temperature 20°C and outdoor temperature Tj										
Tj = -7°C	COP_d	-	3,0	2,0	3,0	1,9	2,6	1,8	2,4	1,8
Tj = +2°C	COP_d	-	4,5	3,2	4,6	3,2	4,1	3,2	3,9	2,8
Tj = +7°C	COP_d	-	6,4	4,4	6,1	4,4	5,7	4,3	5,3	4,4
Tj = +12°C	COP_d	-	8,7	6,5	9,3	6,5	7,8	5,8	7,3	4,9
Tj = bivalent temperature	COP_d	-	3,0	1,9	2,8	1,9	2,6	1,8	2,4	1,8
Tj = operation limit temperature	COP_d	-	2,6	1,6	2,8	1,8	2,4	1,5	2,2	1,6
For air-to-water heat pumps: temperature operating limit	TOL	°C	-10	-10	-10	-10	-10	-10	-10	-10
Water temperature operating limit	WTOL	°C	55	55	55	55	55	55	55	55

Trade name / Product name:	atlantic / ...		Loria 6004		Loria 6006		Loria 6008		Loria 6010	
Reference			522911		522912		522913		522914	
Heating ranges			35°C	55°C	35°C	55°C	35°C	55°C	35°C	55°C
Supplementary heater										
Rated heat output ⁽²⁾	P_{sup}	kW	0,8	1,1	1,1	0,7	0,6	1,8	1,6	1,3
Type of energy input	-	-	Electricity							
Power consumption in modes other than active mode										
Off mode	P_{OFF}	kW	0,009		0,009		0,009		0,007	
Thermostat-off mode	P_{TO}	kW	0,014		0,014		0,015		0,054	
Standby mode	P_{SB}	kW	0,009		0,009		0,009		0,007	
Crankcase heater mode	P_{CK}	kW	0		0		0		0	
Other properties										
Capacity control	-	-	Inverter							
For air-to-water heat pumps, rated air flow rate, outdoors	-	m ³ /h	2070		2340		3600		6200	

^(a) The energy class is that of the product. The energy class scale for products is limited to class A++ until 2019.

⁽¹⁾ The detailed calculations are available on the package sheet. The room appliance refers to: the sensors, room thermostats and offset controllers included or not included in the kits.

⁽²⁾ For room heating devices implementing heat pumps and combined heating devices implementing heat pumps, the rated heat output P_{rated} is equal to the nominal heating load $P_{designh}$ and the rated heat output of a supplementary heater P_{sup} is equal to the supplementary heating capacity $sup(T_j)$.

⁽³⁾ If the C_{dh} is not determined by measurements, the default degradation coefficient is $C_{dh} = 0.9$.

8.3 Package sheet

Outdoor sensor included in the combined package	
Controller class	II
Contribution to seasonal efficiency	2%

Room appliance references	076310
Controller class	VI
Contribution to seasonal efficiency	4%

☞ range 35°C

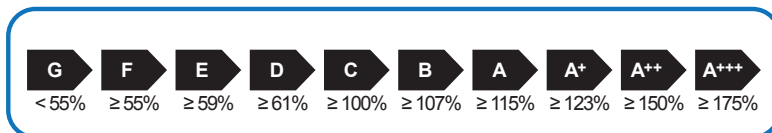

Product name	Loria 6004		Loria 6006		Loria 6008		Loria 6010	
Reference	522911		522912		522913		522914	
Seasonal space heating energy efficiency of heat pump	181%		177%		173%		154%	
Type of control (* = outdoor sensor; ** = Room appliance)	* Class II	** Class VI	* Class II	** Class VI	* Class II	** Class VI	* Class II	** Class VI
Bonus	2%	4%	2%	4%	2%	4%	2%	4%
Seasonal space heating energy efficiency of package under average climates	183%	185%	188%	190%	168%	170%	156%	158%
Package energy class	A+++	A+++	A+++	A+++	A+++	A+++	A++	A++
Seasonal space heating energy efficiency of package under warmer climates	238%	240%	236%	238%	234%	236%	203%	205%
Seasonal space heating energy efficiency of package under colder climates	NA							

The energy efficiency of the combined product described herein may not correspond to its actual energy efficiency once installed in a building, as this efficiency is influenced by other factors such as heat loss in the distribution system and the dimensioning of the products in relation to the size and characteristics of the building.

☞ range 55°C

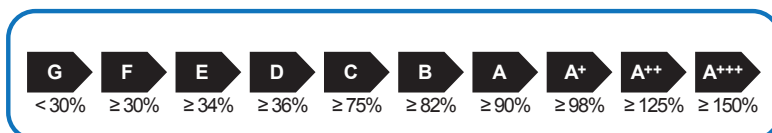

Product name	Loria 6004		Loria 6006		Loria 6008		Loria 6010	
Reference	522911		522912		522913		522914	
Seasonal space heating energy efficiency of heat pump	124%		128%		123%		114%	
Type of control (* = outdoor sensor; ** = Room appliance)	* Class II	** Class VI	* Class II	** Class VI	* Class II	** Class VI	* Class II	** Class VI
Bonus	2%	4%	2%	4%	2%	4%	2%	4%
Seasonal space heating energy efficiency of package under average climates	129%	131%	130%	132%	127%	129%	116%	118%
Package energy class	A++	A++	A++	A++	A++	A++	A+	A+
Seasonal space heating energy efficiency of package under warmer climates	157%	159%	155%	157%	163%	165%	132%	134%
Seasonal space heating energy efficiency of package under colder climates	NA							

The energy efficiency of the combined product described herein may not correspond to its actual energy efficiency once installed in a building, as this efficiency is influenced by other factors such as heat loss in the distribution system and the dimensioning of the products in relation to the size and characteristics of the building.



This unit is identified by this symbol. It means that all electrical and electronic products must not be included in household waste. A specific recycling system for this type of product has been set up in European Union countries (*), Norway, Iceland and Liechtenstein. Do not try to dismantle this product yourself. It may have damaging effects on your health or on the environment. Reprocessing of the refrigerant, lubricant and other parts may be performed by a qualified installer in compliance with the local and national legislation in force. This unit must be recycled by a specialised service and in no case may it be thrown away with household waste, rubble or in a landfill. Please contact your installer or local representative for more information.

* Depending on the national regulations of each member state.

Date of commissioning:

Address of your heating installer or customer service.



atlantic-comfort.com
Société Industrielle de Chauffage

SATC - BP 64 - 59660 MERVILLE - FRANCE